

FROMMELT FOR PROTECTION



RETRACTABLE CABLE CURTAIN



Combining a safety curtain and a suspension device, the **X-TEN** is a versatile area protection system. By conveniently extending and retracting, the **X-TEN** can span distances up to 26 feet, thus providing an effective method of area protection. The **X-TEN** can be used in combination with additional curtains for corner, perimeter, or open floor cells.

The **X-TEN** is ideal for manufacturing workcells where overhead suspension systems can interfere with material handling. The **X-TEN** allows the cable and curtain to be removed easily, enabling passage of overhead cranes and material handling equipment. The **X-TEN** can then be re-extended for safe area protection.



The **X-TEN** curtain stores on the cable guide, and the entire assembly can be rotated 180° for safe storage.

A FEW COMPONENTS MAKE THE COMPLETE SYSTEM:

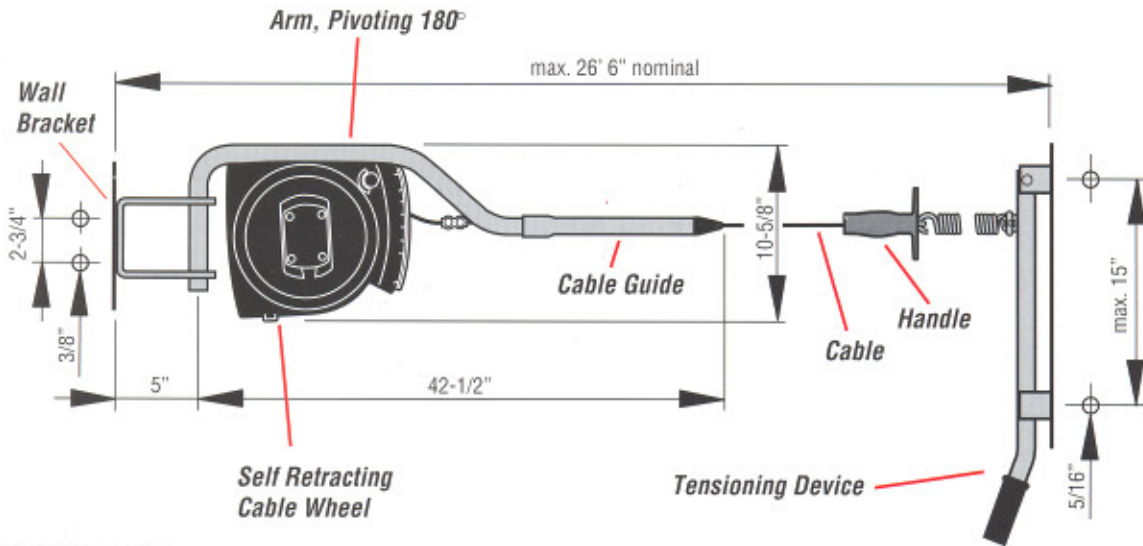

EASY OPERATION:

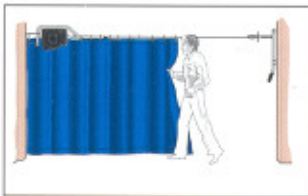

1 First slide the curtain onto the cable guide.

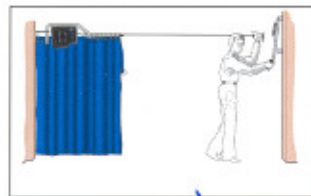

2 Then release the handle which retains the cable on the opposite side of the bay.



3 The cable retracts automatically onto the drum. All you have to do is follow until the handle locates on the cable guide.









4 You may then turn the complete hanger through 180° to swing both the curtain and hanger out of the way in only a couple of seconds.

STANDARD FABRICS:

The X-Ten™ system is available in a range of fabrics depending upon application. The standard safety curtain included is 5' or 6' high and 26' wide, hangers included.

SAF-T-VU™ – This heavy-duty (.012" to .014") transparent vinyl film is CFM approved and available in yellow, orange, green, gray, blue, clear or Shade 8. Service range: 3° to 165° F.

- | | | |
|---|--|--|
|  SVO Saf-T-Vu™ Orange |  SVC Saf-T-Vu™ Clear |  SVGN Saf-T-Vu™ Green |
|  SVB Saf-T-Vu™ Blue |  SVGY Saf-T-Vu™ Gray |  SV8 Saf-T-Vu™ Shade 8 |
|  SVY Saf-T-Vu™ Yellow | | |

WELD-TEX™ – Carrying CFM approval, vinyl-coated 16 oz Weld-Tex resists oils, alkalis and most acids along with fire, water and mildew. Available in yellow and green. For use as curtains or vertical partitions, welding and grinding screens. Service range: -40° to 180° F continuous.

- | | |
|--|--|
|  WTY Weld-Tex Yellow |  WTGN Weld-Tex Green |
|--|--|

ZEBRA – Identical in composition to Weld-Tex with distinctive yellow-and-black stripes on the face and solid black on the reverse.

- | |
|--|
|  Z Zebra Yellow/Black Stripe |
|--|

OTHER FABRICS AVAILABLE. Consult factory.



Visit our Web Site at:
www.frommeltssafety.com

4343 Chavenelle Drive
Dubuque, Iowa 52002-2654
Toll Free: 800-553-5560
Fax: 319-589-2754



4-98
Life in U.S.A.